

Moulée/Mould



Filée/Profile



- GAT500_/PL070 Poutre/ Truss Lg 0,70 m
- GAT500_/PL140 Poutre/ Truss Lg 1,40 m
- GAT500_/PL210 Poutre/ Truss Lg 2,10 m
- GAT500_/PL280 Poutre/ Truss Lg 2,80 m

ANGLES/CORNER Aluminium

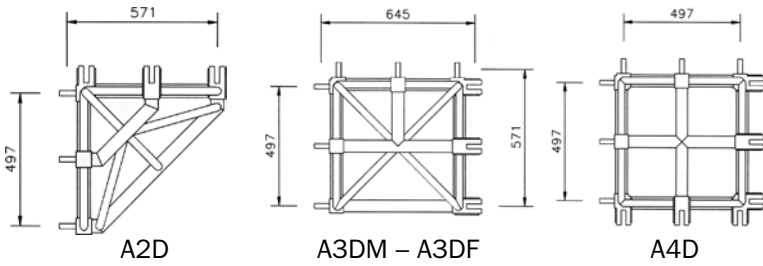

ANGLES/CORNER Acier/Steel

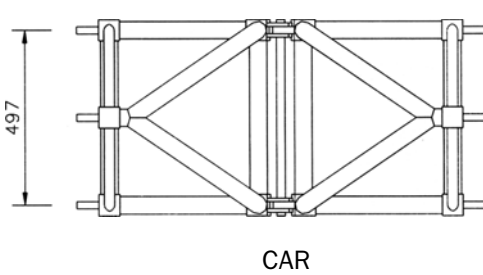
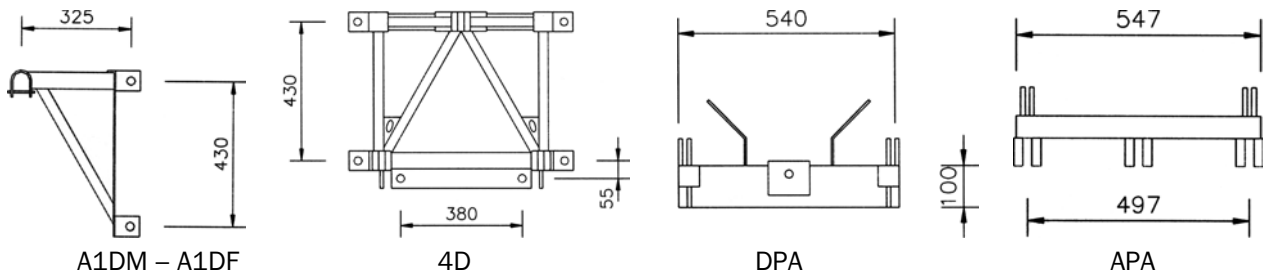

CAR

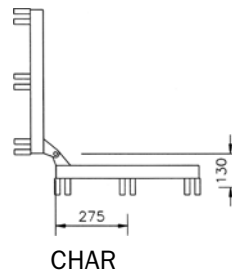

CHAR

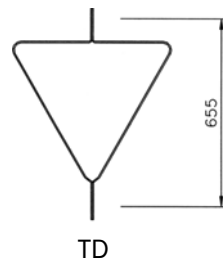

TD

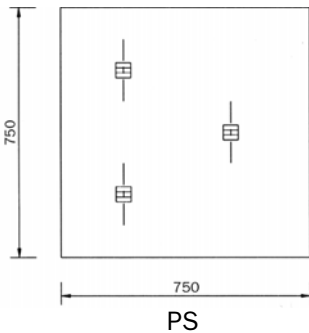

PS

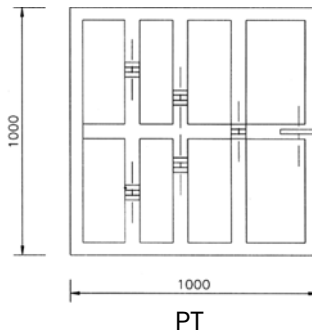

PT

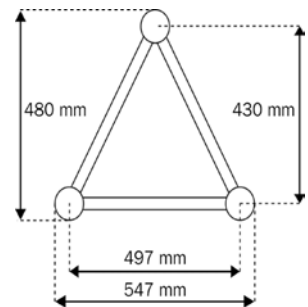

- Tube alu Ø 50 mm x 5 mm
- Entretôises 30 x 3 mm
- Chape Filée ou Moulée



GA

CS

MA

CG

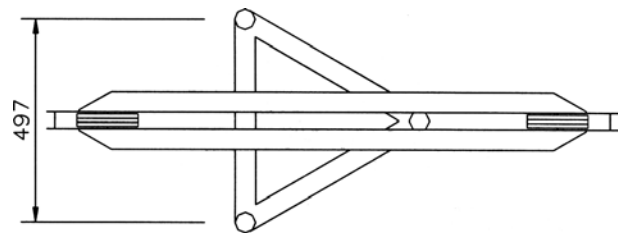
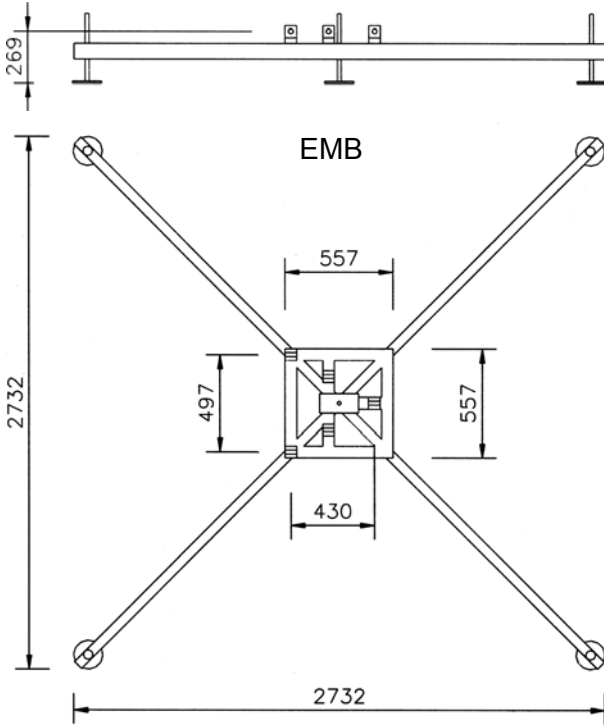

BEQ

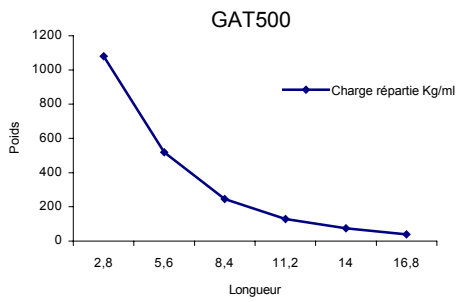

Lest obligatoire



EMB - LRD